

Robotics III: Sensors

Chapter 4: External Sensors

Tamim Asfour

Department of Informatics, Institute for Anthropomatics and Robotics (IAR)
High Performance Humanoid Technologies Lab (H²T)

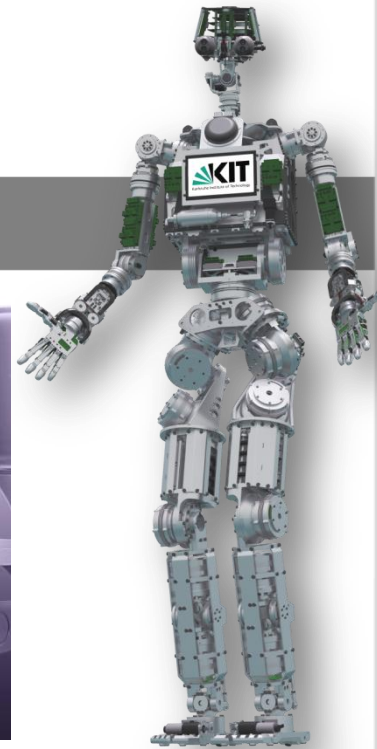
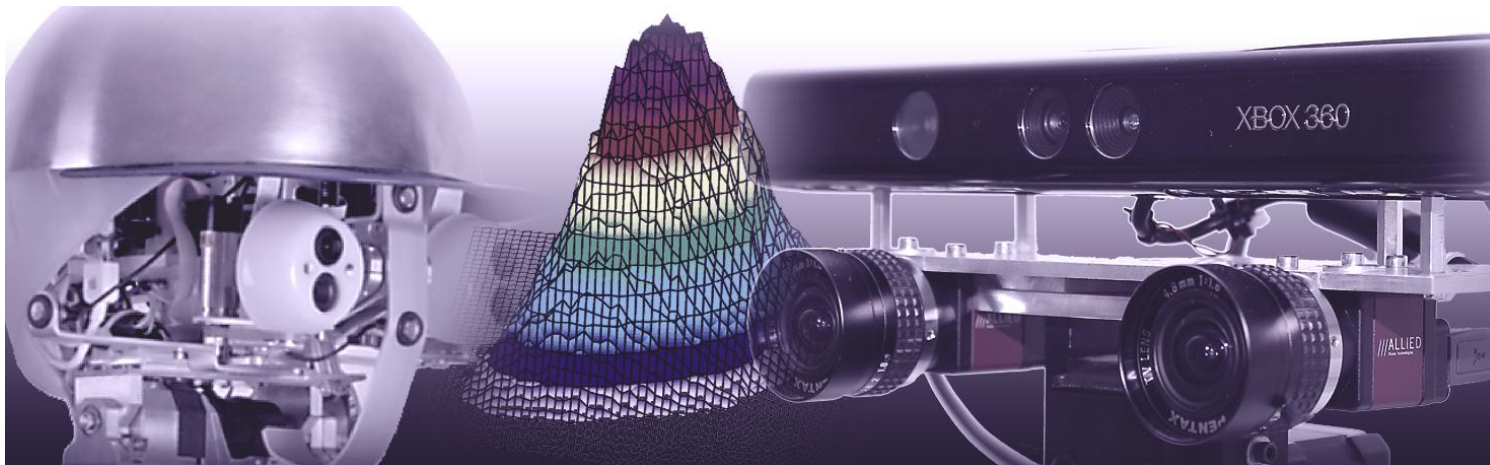

<http://www.humanoids.kit.edu>

<http://h2t.anthropomatik.kit.edu>

Lecture-free Weeks – Robotics III

- Please note the deadline, announcements on the Robotics III – ILIAS Webpage or emails via ILIAS!
- No lecture on:
 - **26.05.2017**
 - **16.06.2017**



Robotik III - Sensoren in der Robotik

Aktionen

— Die Robotik III Vorlesung ergänzt die Robotik I um einen breiten Überblick zu in der Robotik verwendeter Sensorik und dem Auswerten von deren Daten. Ein Schwerpunkt der Vorlesung ist das Thema Computer Vision, welches von der Datenakquise, über die Kalibrierung bis hin zu Objekterkennung und Lokalisierung behan-
 delt wird. Sensoren sind wichtige Teilkomponenten von Regelkreisen und Steuerungen und befähigen Roboter, ihre Aufgaben sicher auszuführen. Darüber hinaus dienen
 Sensoren der Erfassung der Umwelt sowie dynamischer Prozesse und Handlungsabläufe im Umfeld des Roboters. Die Themengebiete, die in der Vorlesung angespro-
 chen werden, sind wie folgt: Sensortechnologie für eine Taxonomie von Sensorsystemen (u.a. visuelle und 3D-Sensoren), Modellierung von Sensoren, Theorie und Praxis dig
 Signalverarbeitung, Maschinensehen, Multisensorintegration und Multisensordatenfusion. — Die grundlegenden Vorlesungsinhalte werden durch mehrere Live-
 Vorführungen neuester Sensorik im Bereich autonome Servicerobotik ergänzt.

Inhalt
Info
Einstellungen
Mitglieder
Lernfortschritt
Metadaten
Export
Rechte
Voransicht als Mitglied aktivieren >

Zeigen
Verwalten
Sortierung
Seite gestalten

Neues Objekt hinzufügen ▾

Nachrichten (1-5 von 9) ▾

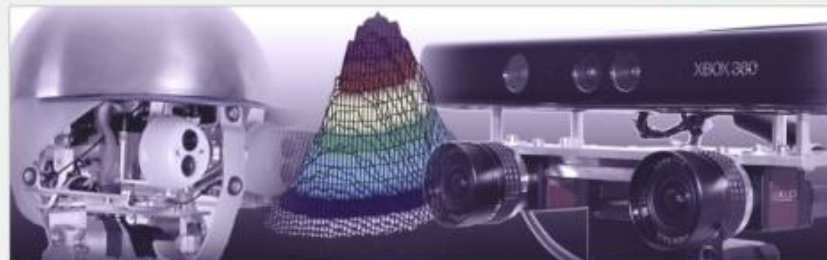

Kurs: Robotik III - Sensoren in der Robotik
 Ausfälle - Robotik 3 - SS 2017
 Datei: 03 Robotik III-Taktile Senso und KMS-Tamim.pdf
 Die Datei wurde hinzugefügt.
 Datei: 02 Robotik III-Interne Sensoren-Tamim.pdf
 Die Datei wurde hinzugefügt.
 Datei: Robotics-III-Chapter-01-Intro...
 Die Datei wurde hinzugefügt.
 Datei: signalverarbeitung.pdf
 Die Datei wurde hinzugefügt.

Die Vorlesung fällt an folgenden Freitagen aus: 26.05., 16.06.!

Inhalt:
 Die Robotik III Vorlesung ergänzt die Robotik I um einen breiten Überblick zu in der Robotik verwendeter Sensorik und dem Auswerten von deren Daten. Ein Schwerpunkt der Vorlesung ist das Thema Computer Vision, welches von der Datenakquise, über die Kalibrierung bis hin zu Objekterkennung und Lokalisierung behandelt wird.

Sensoren sind wichtige Teilkomponenten von Regelkreisen und Steuerungen und befähigen Roboter, ihre Aufgaben sicher auszuführen. Darüber hinaus dienen Sensoren der Erfassung der Umwelt sowie dynamischer Prozesse und

Kalender < Mai 2017 >

KW	Mo	Di	Mi	Do	Fr	Sa
----	----	----	----	----	----	----

Sensor Types – External (Exteroceptive) Sensors

External Sensors

Tactile Sensors

Touch & Slip Sensors

Force/Torque Sensors



Proximity Sensors

Capacitive Sensors

Optical Sensors

Acoustic Sensors



Distance Sensors

Time of Flight-based

Triangulation-Based



Visual Sensors

Photodiodes

CCD/CMOS

Stereo

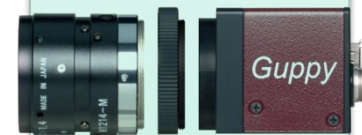

Position Sensors

GPS

Natural/
artificial
Landmarks

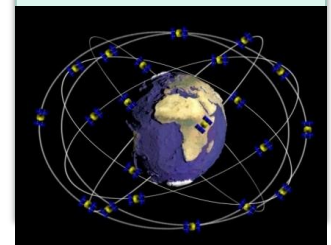

Proximity Sensors

- Detect objects within a specific range from the robot
- Provide binary signal according to some threshold
- Determine the presence of an object at a specified distance
- Proximity sensors are non-contact devices and needed for true obstacle avoidance

- Tactile sensors are an example of proximity sensors
 - Advantage against tactile sensors:
 - No damage to the object
 - Better durability (permanence!)

 - Types:
 - Optical
 - Acoustic

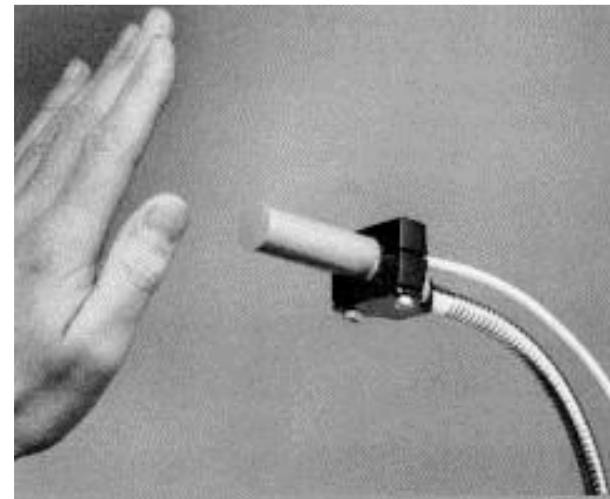

Optical Proximity Sensors

- Rely on light reflection
- Light barrier: Binary output information

- Advantages:

- Greater operating distance
- Non-contact
- Adjustable threshold value

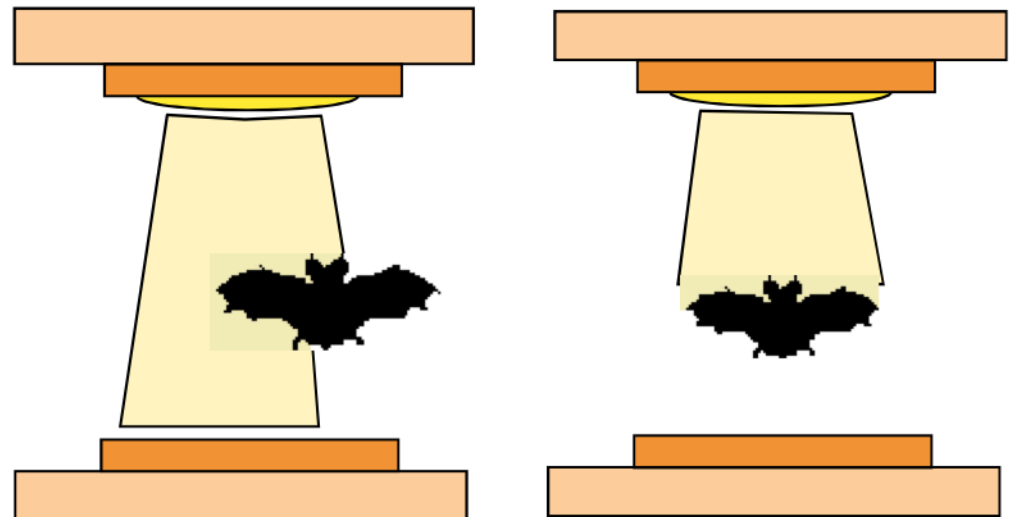

Optical Proximity Sensors

■ Reflective light sensor:

- Red-Light-LED
- Time of Flight measurement /Triangulation with background suppression
- Standard in automation, very cost-effective.



■ Laser reflex light sensor:

- Distance: 7 – 200mm
- Smallest Object Diameter: 1 – 2mm
- Measuring Rates: 1000 – 5000Hz

Acoustic Proximity Sensors

- Acoustic principle for ultrasound
- Also a reflective sensor that responds to changes in the amount of emitted energy returned to a detector
- The transmitter emits a wave in the ultrasonic region of the acoustical spectrum (typically 20-200 KHz) (above the normal limits of human hearing!)

- Advantage:
 - Emission and detection with the same converter
 - Time of Flight distance dependent
 - Useful over distances out to several feet for detecting most objects, liquid and solid.

- Problem:
 - Noise

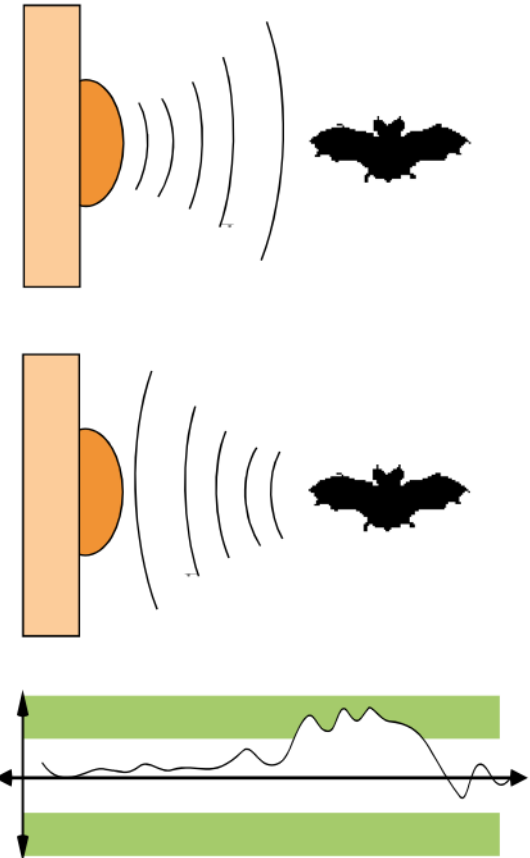

Sensor Types – External (Exteroceptive) Sensors

External Sensors

Tactile Sensors

Touch & Slip Sensors

Force/Torque Sensors

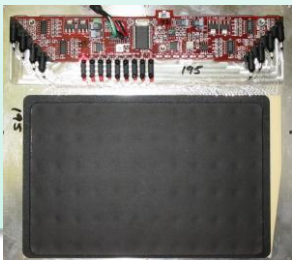

Proximity Sensors

Capacitive Sensors

Optical Sensors

Acoustic Sensors



Distance Sensors

Time of Flight - based

Triangulation-Based



Visual Sensors

Photodiodes

CCD/CMOS

Stereo

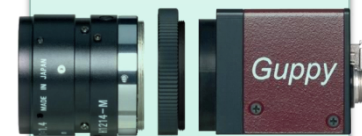

Position Sensors

GPS

Natural/
artificial
Landmarks

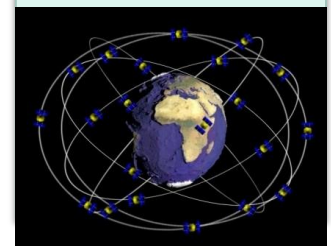

Distance Sensors

- Measurement of the distance between the sensor and the object
- Advantages:
 - Greater range than proximity sensors
 - Exact distance indication instead of binary output
 - Suitable for the detection of geometric environmental information

■ Types:

- Passive Methods
 - Stereo camera systems
- Active Methods
 - Laser scanner
 - TOF camera
 - Laser stripe
 - Pattern projection



Difference:

- The passive methods **do not need** their own light source, but they use the **ambient** light for gathering the distance information
- The active methods have a **light source** of their own for illuminating the target.

Passive Methods – Stereo Vision

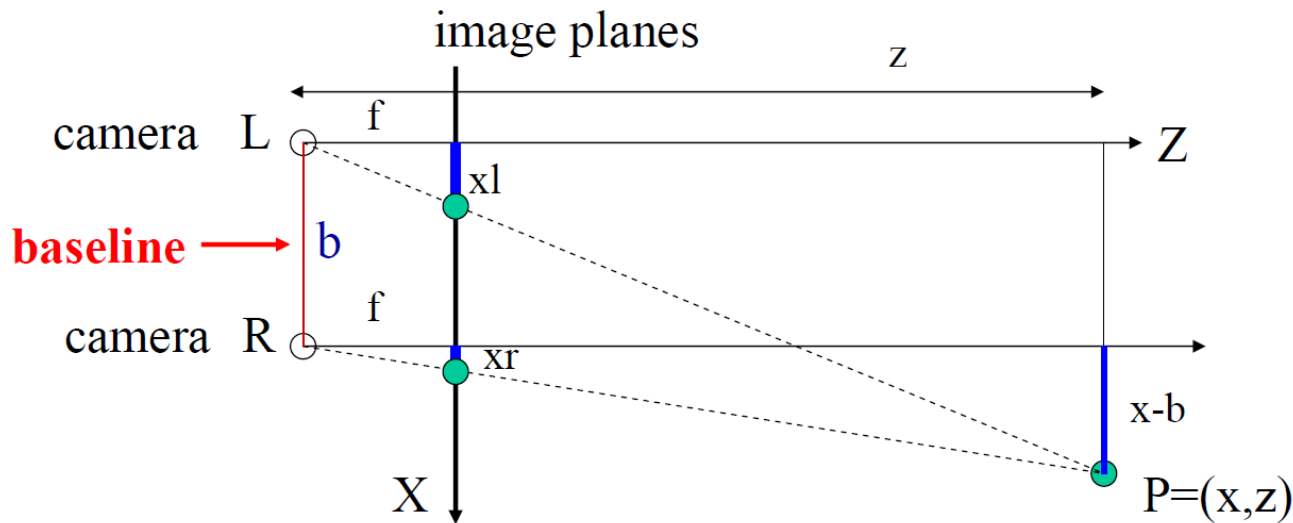

- „Passive Triangulation“ (Triangulation with ambient light)
 - Example: Binoculars and trinocular cameras
 - Depth reconstruction using images from different perspectives
- Operating mode: Object P with different coordinates in image plane → Triangulation of corresponding pixels.
 - Theorem of intersecting lines

Passive Methods – Stereo Vision

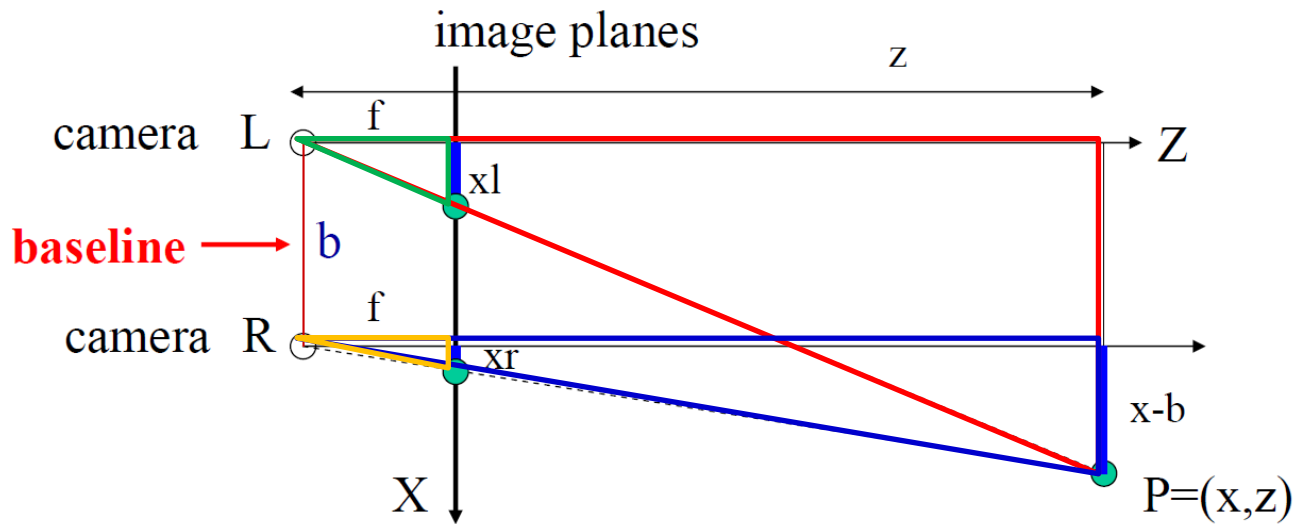

$$\frac{z}{f} = \frac{x}{x_l} = \frac{x - b}{x_r} \quad \Rightarrow \quad z = \frac{f \cdot b}{x_l - x_r} = \frac{f \cdot b}{d}$$

Depth (z) is *inversely proportional* to disparity (d)

Passive Methods – Stereo Vision

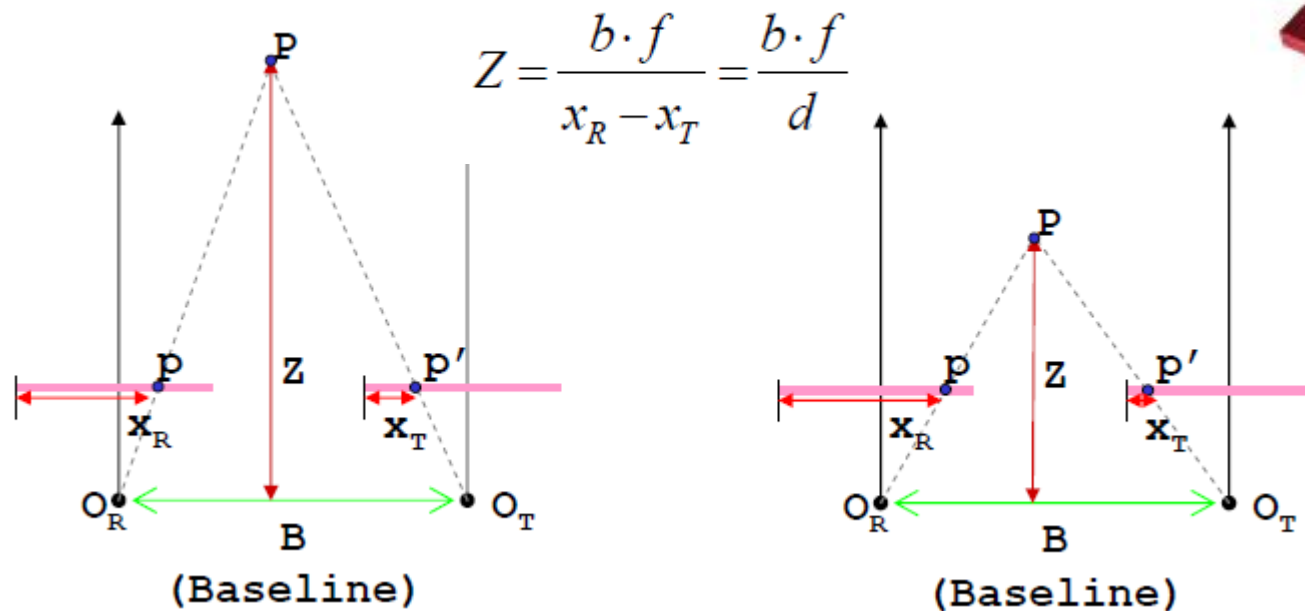

While **close** objects have **significant** disparity, **distant** objects have **less** disparity making it difficult to get accurate depth measurements.

Passive Methods – Stereo Vision

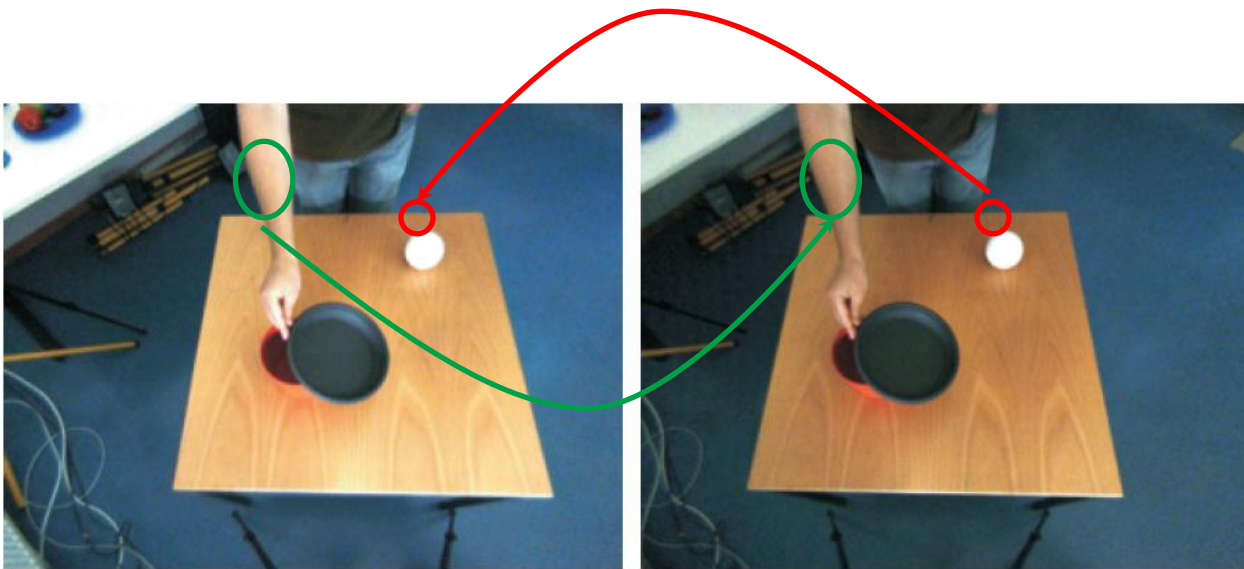

Advantages

- Adjustable focal lengths/baseline
- No special illumination is required

Disadvantages

- At least two calibrated cameras required
- Correspondence problem on homogeneous surfaces
- Occlusion

- Stereo vision is only good for close to mid-range distances, after that we use other clues to figure out distance!...

Passive Methods – Stereo Vision

Problem

- Correspondence problem: What point pairs in the image plane correspond to the same scene element?

- Differences in :

- Brightness
- Color
- Image region

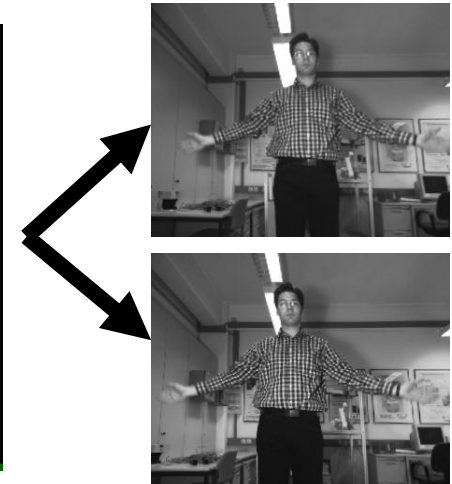
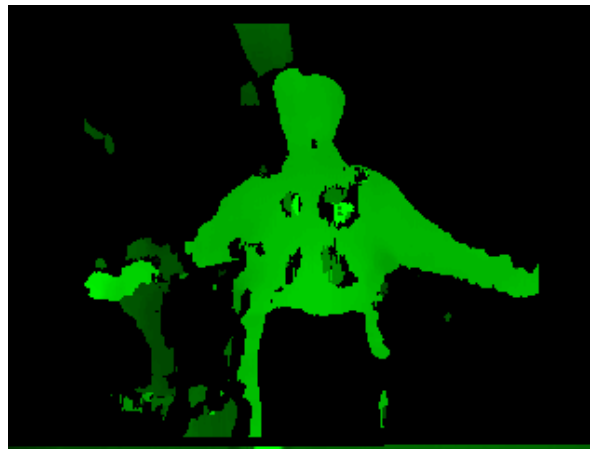

- Solution: ***Epipolar line construction***

- ***Rectification***
- ***Synchronization***

Active Distance Measurement Methods

- Using an active energy source to create an artificial texture on the surface to be measured.
 - Stable against external disturbances
 - Measurement by deflection of the energy source
 - ➔ 2D or 3D Distance measurement

- Active Sensors are based on
 - Time-of-Flight principle
 - Amplitude Modulation principle
 - Triangulation principle

- Generates dense Depth image $P_{ij} = (x_{ij}, y_{ij}, z_{ij}), \quad 1 \leq i \leq m, 1 \leq j \leq n$

- With equidistant quantization in X- and Y-directions

$$Im_{ij} = (z_{ij}), \quad 1 \leq i \leq m, 1 \leq j \leq n$$

Active Distance Measurement Methods

- Using a laser, the distance to the target object can be measured by one of three techniques::
 - **Time-of-Flight:** Sensors based on measuring the Time-of-Flight (TOF) of a pulse of emitted energy traveling to a reflecting object, then echoing back to a receiver.
 - velocity of sound is small enough that it is easy to measure ToF directly (sonar)
 - velocity of light (and radio) is big enough that it is hard to measure ToF directly
 - for short-range ranging with light (lidar) or radio (radar) we measure ToF indirectly i.e., we use the phase of the modulation because it is relatively easy to measure how the phase of the modulation changes with path difference.
 - **Amplitude Modulation:** The phase-shift measurement (or phase-detection) ranging technique involves continuous wave transmission as opposed to the short pulsed outputs used in TOF systems.
 - **Triangulation:** The sensor-object distance is calculated trigonometrically.

Time-of-Flight Method I

- Time-of-flight (TOF) ranging systems measure the round-trip time required for a laser pulse of emitted energy to travel to a reflecting object, then echo back to a receiver.
- Distance (d) from sensor to target surface by: $d = \frac{1}{2} ct$
 - Given signal speed c ,
 - Time of Flight (elapsed time) t is measureable.
 - Must be reduced by half to result in actual range to the target (round-trip!)

- Measurement of t
 - Directly
 - From phase shift of the signal after its modulation

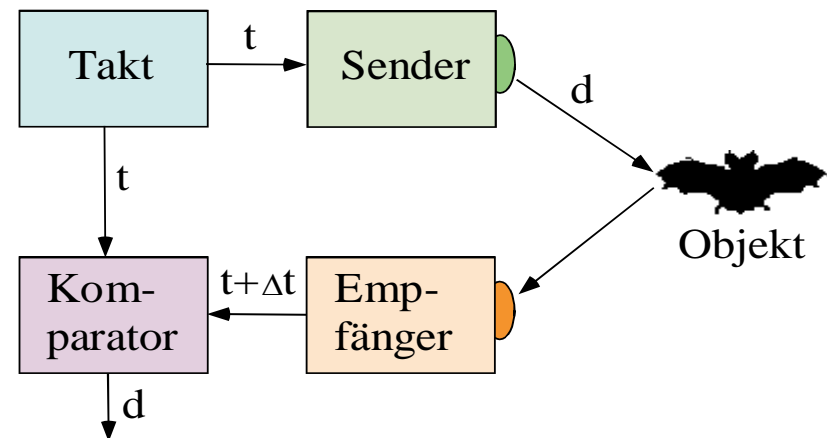

Time-of-Flight Method II

- Although the implementation differs, time-of-flight measurement can be accomplished with
 - Radio waves (radar)
 - Sound or ultrasonic waves (sonar)
 - Light waves (laser radar - lidar)
- The same measuring principle is used for all signal types.
- Potential **error sources** for ToF systems are
 - Variations in the propagation speed:
 - E.g In acoustically based systems, the speed of sound is influenced by temperature changes, and to a lesser extent by humidity.
 - Uncertainties in determining the exact time of arrival of the reflected pulse.
 - Inaccuracies in the timing circuitry used to measure the round-trip time of flight.
 - Interaction of the incident wave with the target surface.

Time-of-Flight Method III

- Typical (signal type dependent) problems:

Absorption of the beam

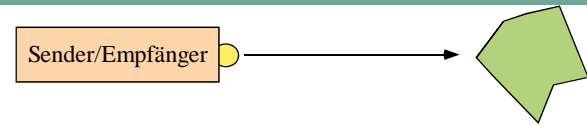

Scattering

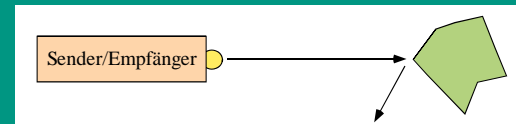

Multi path reflection

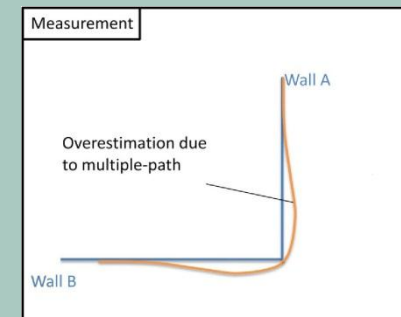
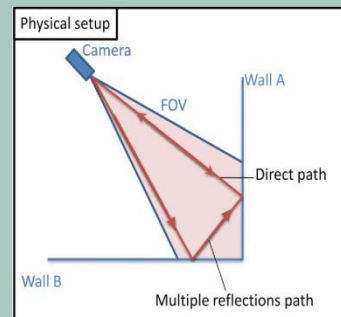

Time-of-Flight Method: Radar

- Radar is an active external sensor and usually uses electromagnetic energy in the 1 - 12.5 GHz frequency range
 - this corresponds to wavelengths of 30 cm - 2 cm (microwave energy)
 - unaffected by fog, rain, dust, haze and smoke
 - Purpose: detection, location, distance measurement
 - Transmitter: strongly bundled waves in the mm, cm & dm ranges as short pulses (high transmission power, clear reflection)
 - Receiver: registers reflections between the pulses
 - Diameter of a radio wave bundle is inversely proportional to the antenna size.
 - Large antenna is required for fine resolution.
 - Radio waves spread with light speed.
- Accurate time measurement over short distances
– only with extremely complex electronics.



Time-of-Flight Method: Ultrasonic I

- Sonic means Sound and Ultrasound (sonar) refers to the range of frequencies of sound that are beyond human hearing
- The operation principle of sonar sensors includes
 - the emission of a short acoustic signal (of duration about 1 ms) at an ultrasonic frequency of 50-250 kHz
 - and the measurement of the time from signal emission until the echo returns to the sensor.
- Ultrasonic sensors emit a chirp (e.g. 1.2 milliseconds), where a chirp is a short powerful pulse of a range of frequencies of sound
- As the speed of sound in air is known the distance to the object can be computed from the elapsed time between chirp and echo
- Usually referred to as ultrasonic sensors or sonar sensors
- An ultrasonic sensor array helps to detect any obstacle(s) and works with the motion platform controller to avoid collisions with the obstacles.

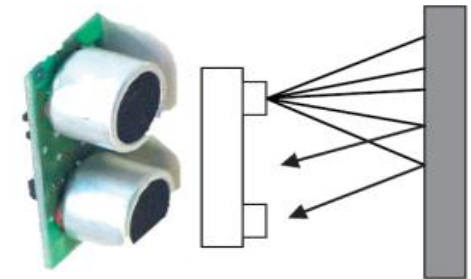

Time-of-Flight Method: Ultrasonic II

- There are a number of problems about readings from sonar sensors
 - They have a relatively narrow cone, e.g. for a 360° coverage, a typical mobile robot sensor configuration is to use 24 sensors, each one mapping a cone of about 15° each.
 - It is difficult to be sure in which direction an object is because the 3D sonar beam spreads out as it travels
 - Specular reflections give rise to erroneous readings
 - The sonar beam hits a smooth surface at a shallow angle and so reflects away from the sensor
 - Only when an object further away reflects the beam back does the sensor obtain a reading - but distance is incorrect
 - Arrays of sonar sensors can experience crosstalk
 - One sensor detects the reflected beam of another sensor
 - The speed of sound varies with air temp. and pressure
 - A 16° C temp. change can cause a 30cm error at 10m!
 - Distance and angular resolution decreases as objects become further from the sensor

Time-of-Flight Method: Laser Range Finder

- Laser range finders commonly used to measure the distance, velocity and acceleration of objects
 - Also known as laser radars (or LiDARs= Light Detection and Ranging sensors)
- The operating principle is the same as sonar
 - A short pulse of (laser) light is emitted (note that speed of light \gg speed of sound)
 - The time elapsed between emission and detection is used to determine distance (using the speed of light)
- Laser sensors supply speed and height.
- May not detect transparent surfaces (e.g. glass!) or dark objects
- So far:
 - Time from the phase shift of the detector signal relative to the phase of the emitted signal.
- Alternative
 - Instead of light pulses emit continuous laser light.
 - Amplitude Modulation: The light power is sinusoidal with frequency modulate.

Amplitude Modulation

- A beam of amplitude-modulated laser, RF, or acoustical energy is directed towards the target.
- A small portion of this wave reflected by the object's surface back to the detector along a direct path.
- The returned energy is compared to a simultaneously generated reference that has been split off from the original signal, and the relative phase shift between the two is measured to ascertain the round-trip distance the wave has traveled.

- Transmitter: emits signal, whose power is modulated with the frequency of $1/\lambda$
- Receiver: detects the signal reflected from the target surface, and notices shifting of the receiver signal against emitted light (reference signal) by Φ .

Amplitude Modulation

- A beam of amplitude-modulated laser, RF, or acoustical energy is directed towards the target.
- A small portion of this wave reflected by the object's surface back to the detector along a direct path.
- The returned energy is compared to a simultaneously generated reference that has been split off from the original signal, and the relative phase shift between the two is measured to ascertain the round-trip distance the wave has traveled.

- The phase shift Φ is

$$\Phi = \frac{4\pi d}{\lambda}$$
 $d = \text{distance to target}$
 $\lambda = \text{modulation wavelength}$

- The distance is

$$d = \frac{\Phi \lambda}{4\pi} = \frac{\Phi c}{4\pi f}$$
 $c = \text{speed of light}$
 $f = \text{modulation frequency}$

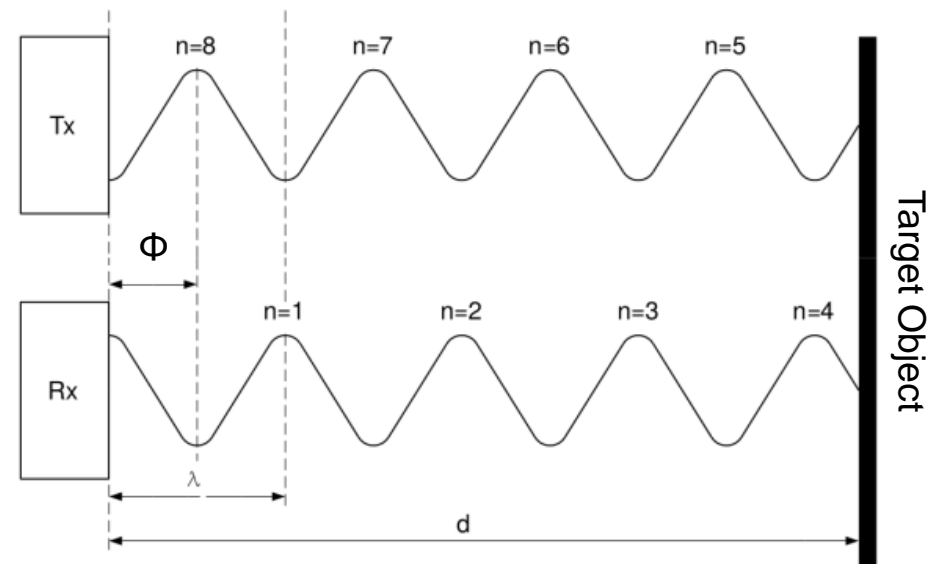

Amplitude Modulation

- Advantages of this special case of running time measurement:
 - Higher resolution compared to direct Time-of-Flight measurement
 - Lower measurement effort

- Problems:
 - Problem: $\Delta\lambda > \lambda$ is not recorded
 - Relative phase shift only modulo 2π determinable
 - Limited range of unambiguity of distance measurements
 - Measurement distance is less since light (laser) necessarily operates continuously at low power

Amplitude Modulation: Example SICK LMS

- Optical 2D distance sensor
- Infrared laser scanner
- Angle resolution: $\frac{1}{4}^\circ$, $\frac{1}{2}^\circ$, 1°
- Field of view: 180°
- Scanning range: 0 – 80m
- Absolute accuracy: 1,5cm
- Scanning Accuracy: 0,5cm
- Scanning Frequency: 75Hz

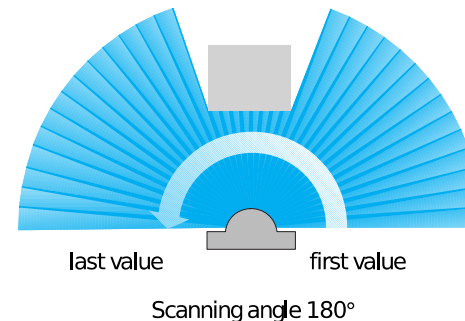

Example: SICK LMS 200 for Path Planning

- Distance sensors for path planning: Application example



Use of a planar laser scanner for obstacle detection and position determination

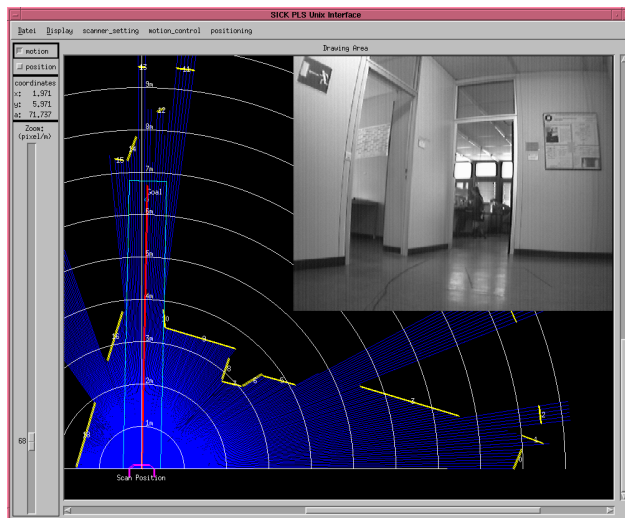

Example: SICK LMS 200 - RoSi

- Optical 3D distance sensor
- Rotating SICK LMS 200
- Max. rot. Resolution: 0,005°
- Measurement duration: 2,7s (at 1° lateral and rotational resolution)
- Foveal seeing
- Integration of Color data in „depth data“

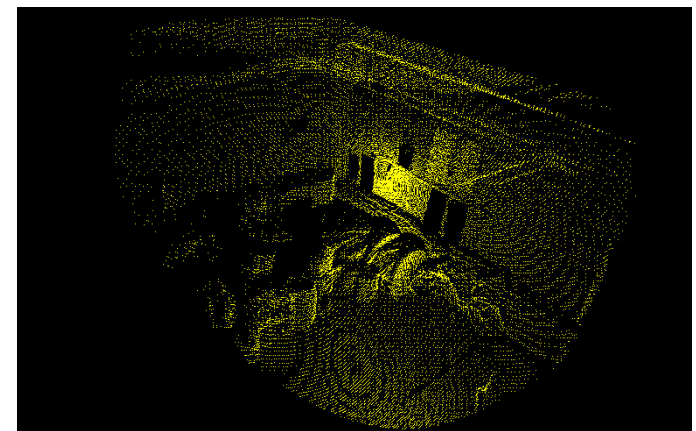
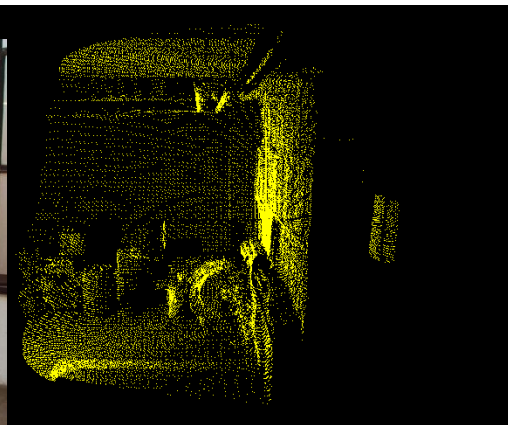
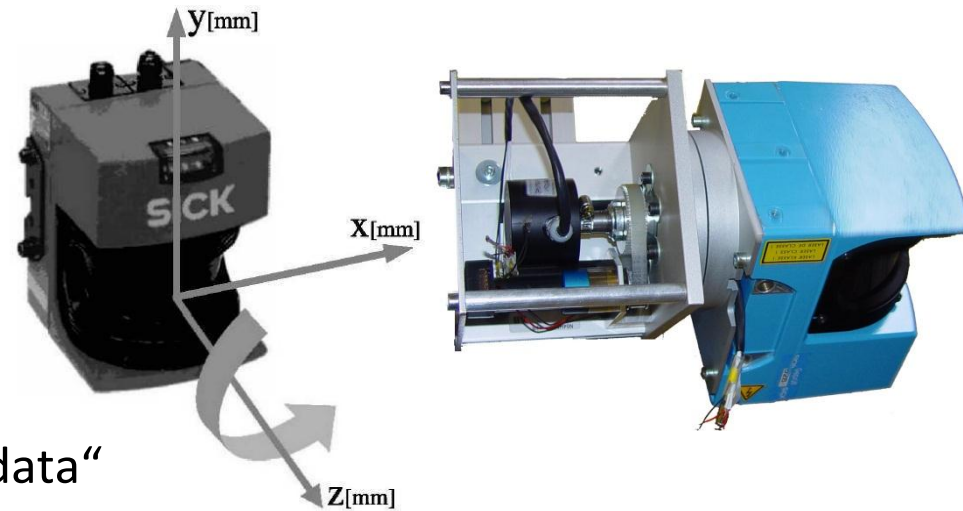

Example: SICK LMS 200 - RoSi



- Disadvantages:
 - Measuring 3D by means of a 2D scanner needs time
 - Problems with dynamic (self motion, motion in the environment)

Example: MESA SwissRanger 4000

- LED array based 3D distance sensor
- Infrared light - time-of-flight camera
- Higher frequency, lower accuracy
- Measuring range: 0,8m – 5m
- Resolution: 176 x 144
- Scanning frequency: 50Hz
- Absolute accuracy: 1cm to 1,5cm
- Scanning accuracy: 4mm to 6mm

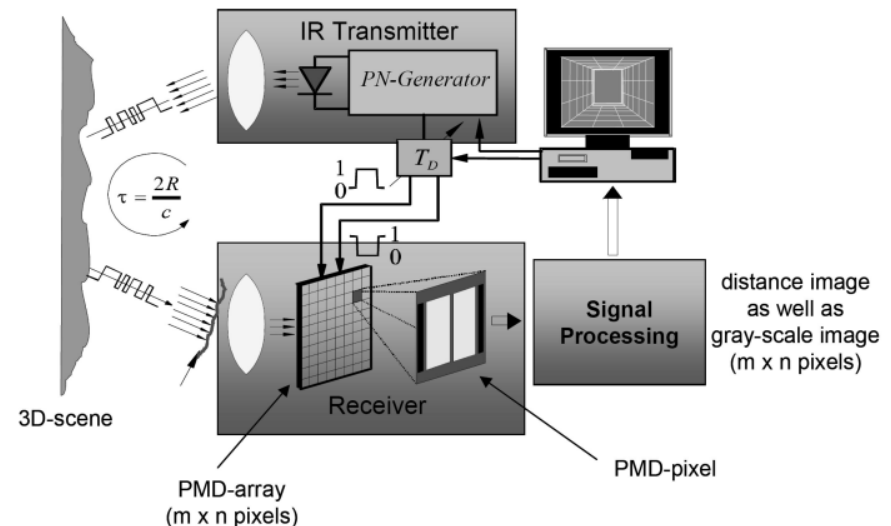
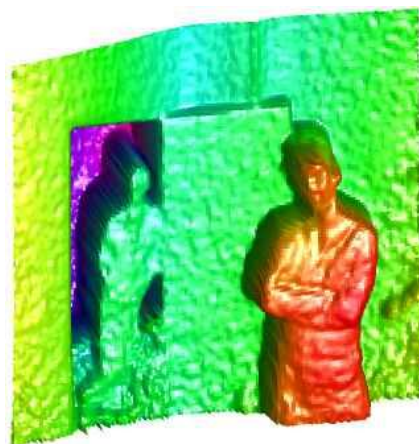

Amplitude Modulation : MESA SwissRanger 4000

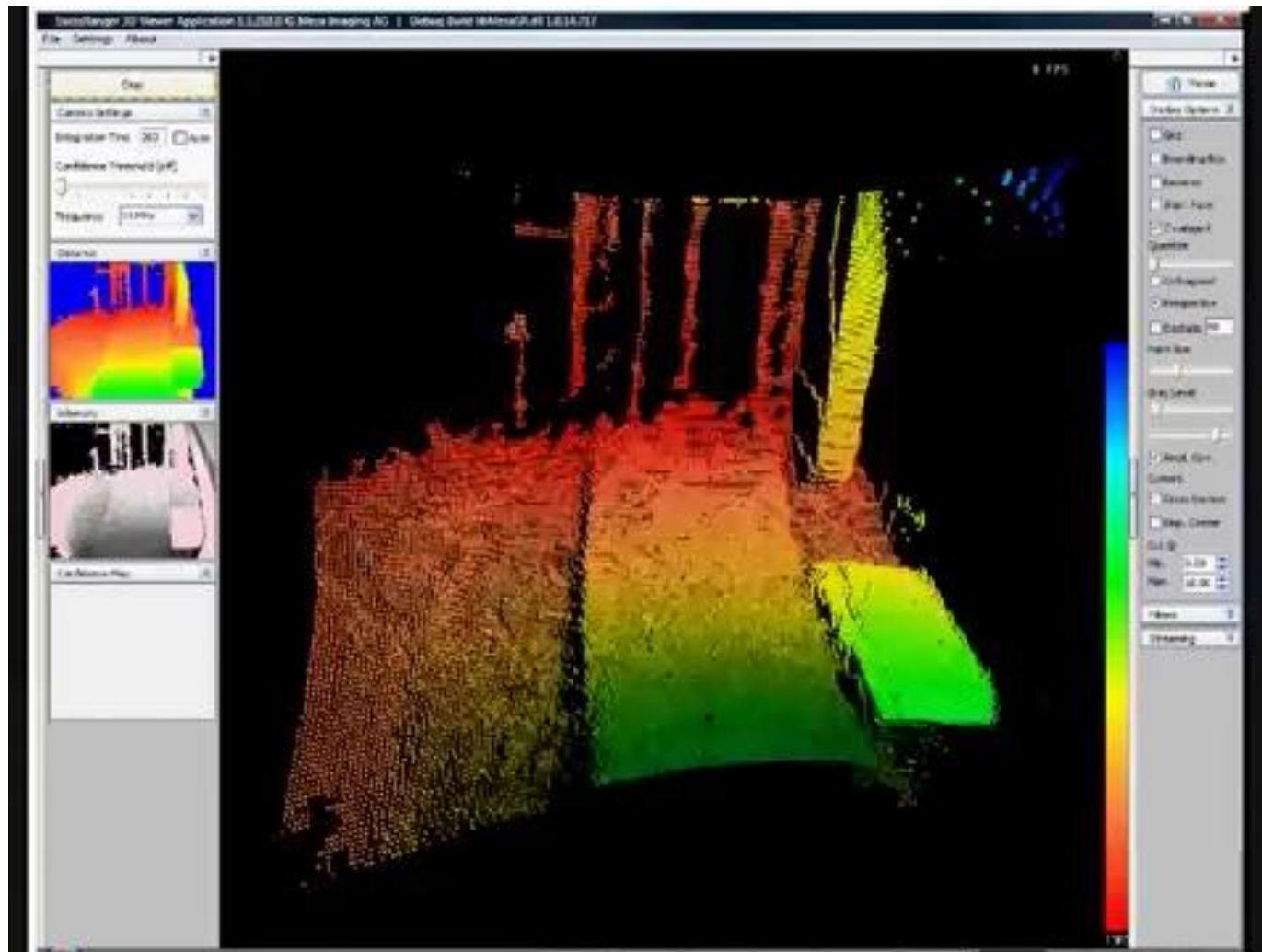

Triangulation Method

■ Active Triangulation

- Transition from stereo vision to active triangulation by exchanging one of the two stereo cameras with active light source
- Project the laser beam into the scene and record it using a position-sensitive sensor
- Simplification of the correspondence problem

■ Projections of different complexity

- Single light beam
- Laser line (light section)
- Projection of an encoded pattern (Structured light)

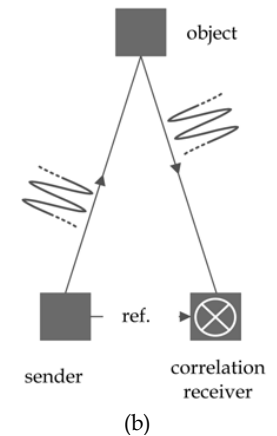
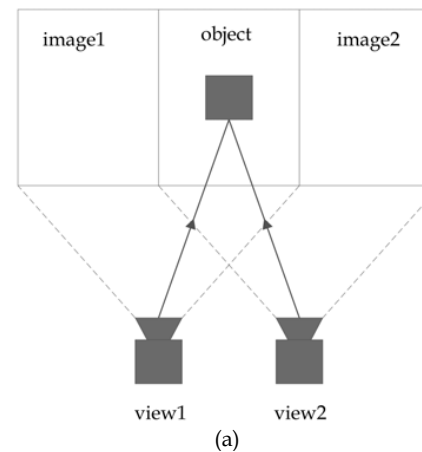

S. Hussmann, T. Ringbeck, B. Hagebecker. A Performance Review of 3D TOF Vision Systems in Comparison to Stereo Vision Systems. 2008.

Active Triangulation: Geometry

- Fixed transmitting and receiving unit
 - Triangle: Emitter-Object-Detector
- Measurement of the deflection of the beam
 - Known:
 - Angles α , β und distance c , thus point at d

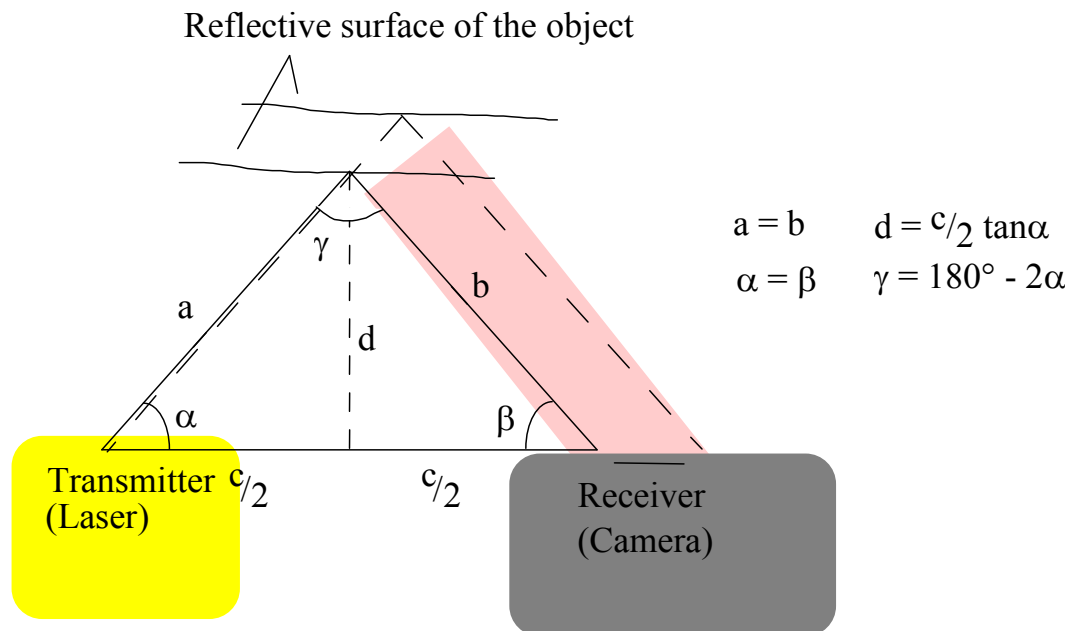
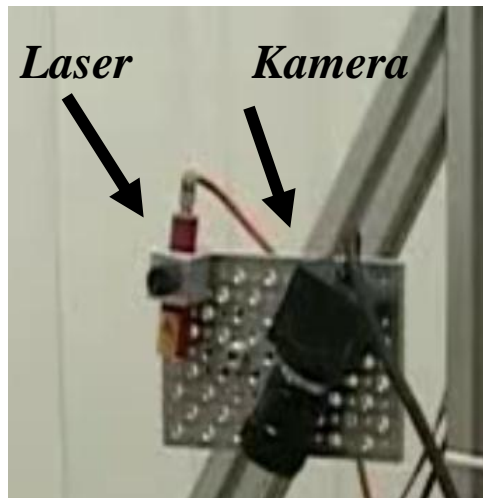

Active Triangulation: Geometry

- A sensor emits a laser light that hits the object at some incidence angle, reflects from it and detected
- Since light moves in straight lines, a triangle is formed between the laser source, the measured object, and the detector.
- By measuring the exact location the laser hits the detector we can calculate the distance to the object using simple geometry

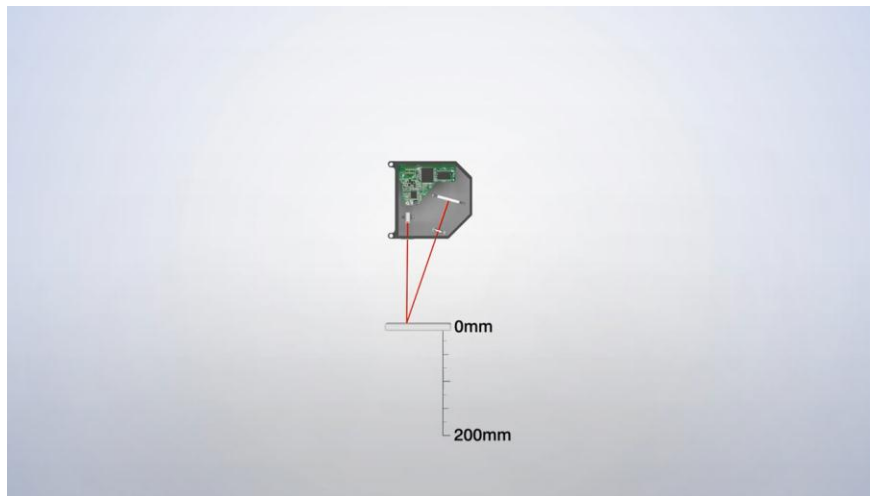
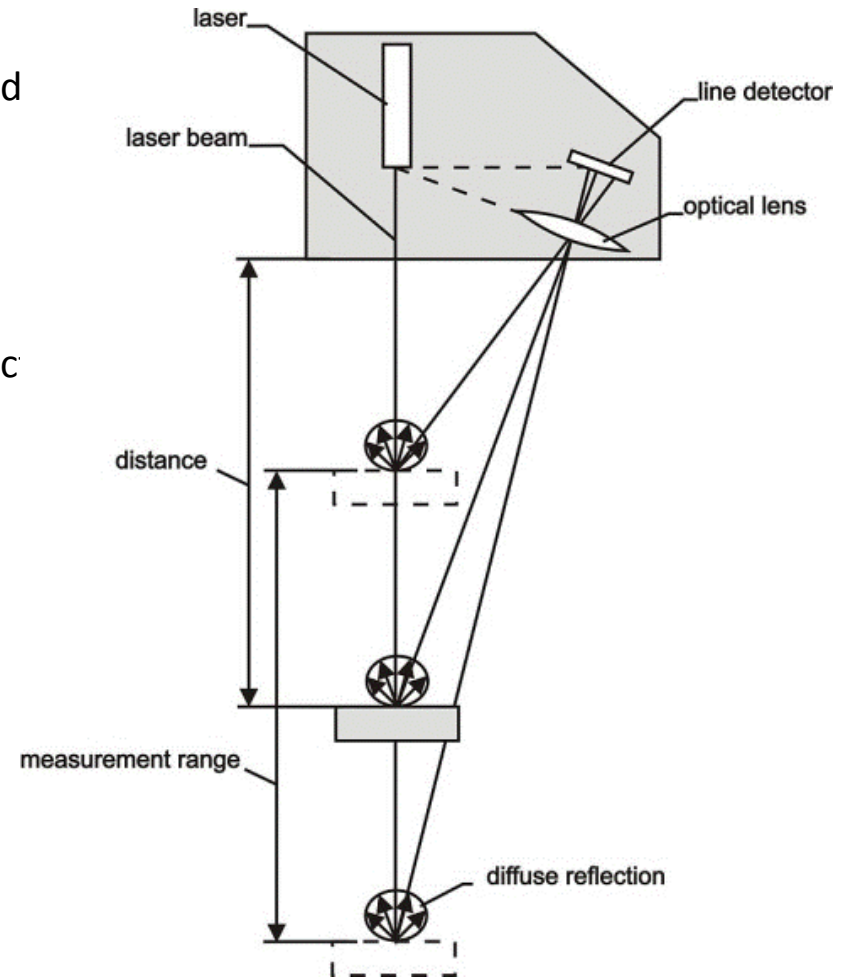

Active Triangulation: Laser-base I

- Triangulation based on cosine-law delivers depth info.
- **Single Spot-Projection**
 - The triangulation principle.
 - The distance c between camera and laser as well as the angle α and the camera position are known from the sensor design.
 - The measured position of the reflected light point in the sensor chip allows the calculation of all unknown triangle parameters and thus the 3D coordinates of the measuring point can be calculated.
- **Sheet of Light-Projection**
 - The extension of the triangulation principle to the light-stripe technique.
 - All points along the image of the laser line can be triangulated in one single image.

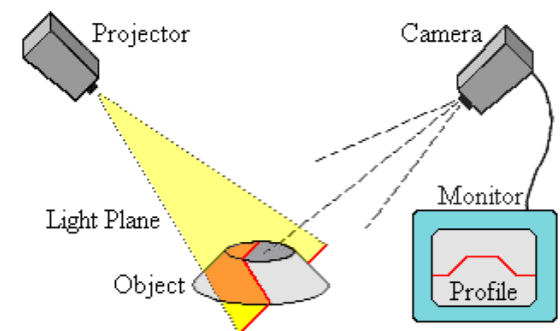
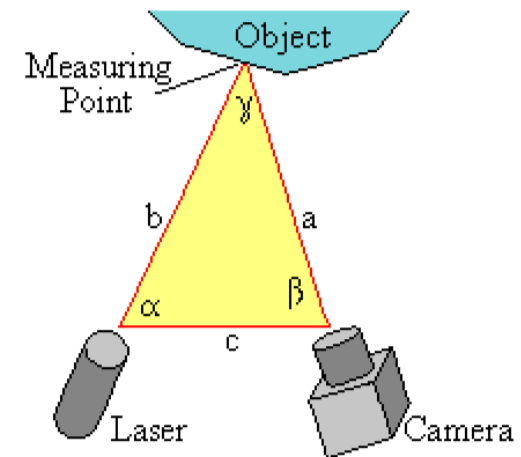

Active Triangulation: Laser-base II

- Scanning with laser stripes

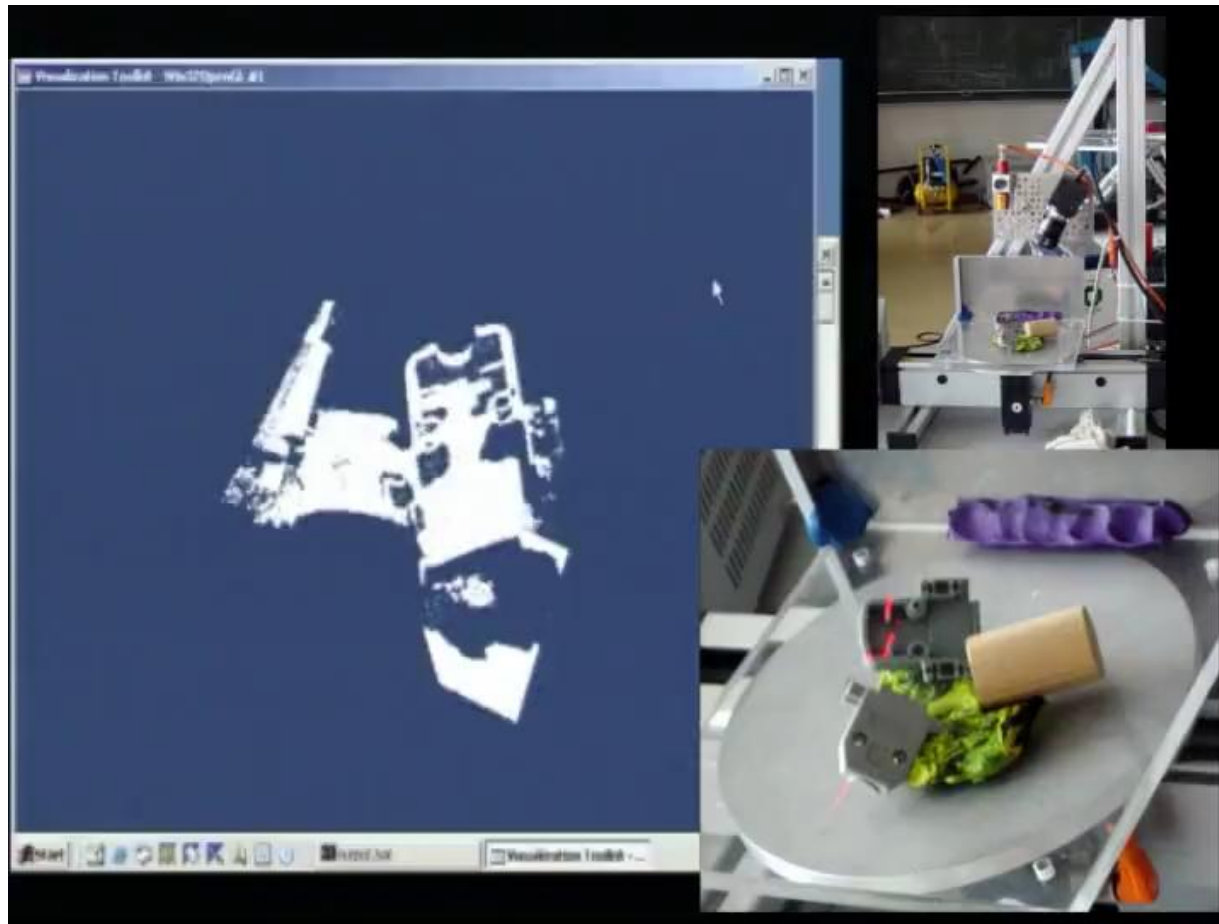

Scanning with Laser Stripes: Example Minolta Vi-900

- This sensor uses the light-stripe method to emit a horizontal stripe light through a cylindrical lens to the object.
- The reflected light from the object is received by the CCD, and then converted by triangulation into distance information.
- This process is repeated by scanning the stripe light vertically on the object surface using a mirror, to obtain a 3D image data of the object.

- Light-cut process – Laser swings in the device
- Measuring range: 60cm – 120cm
- Resolution: 640 x 480
- Measuring time: 0,3s – 2,5s
- Accuracy: ~0,047mm (at 60 cm distance)
- Weight: approx. 11kg



Scanning with Laser Stripes: Example Minolta Vi-900



Coded Structured Light: Pattern encoding/decoding

- Projection of many strips simultaneously
- Correspondence problem: Which laser line in the camera image corresponds to which line of the projector?
- Answer: Coded stripe patterns!

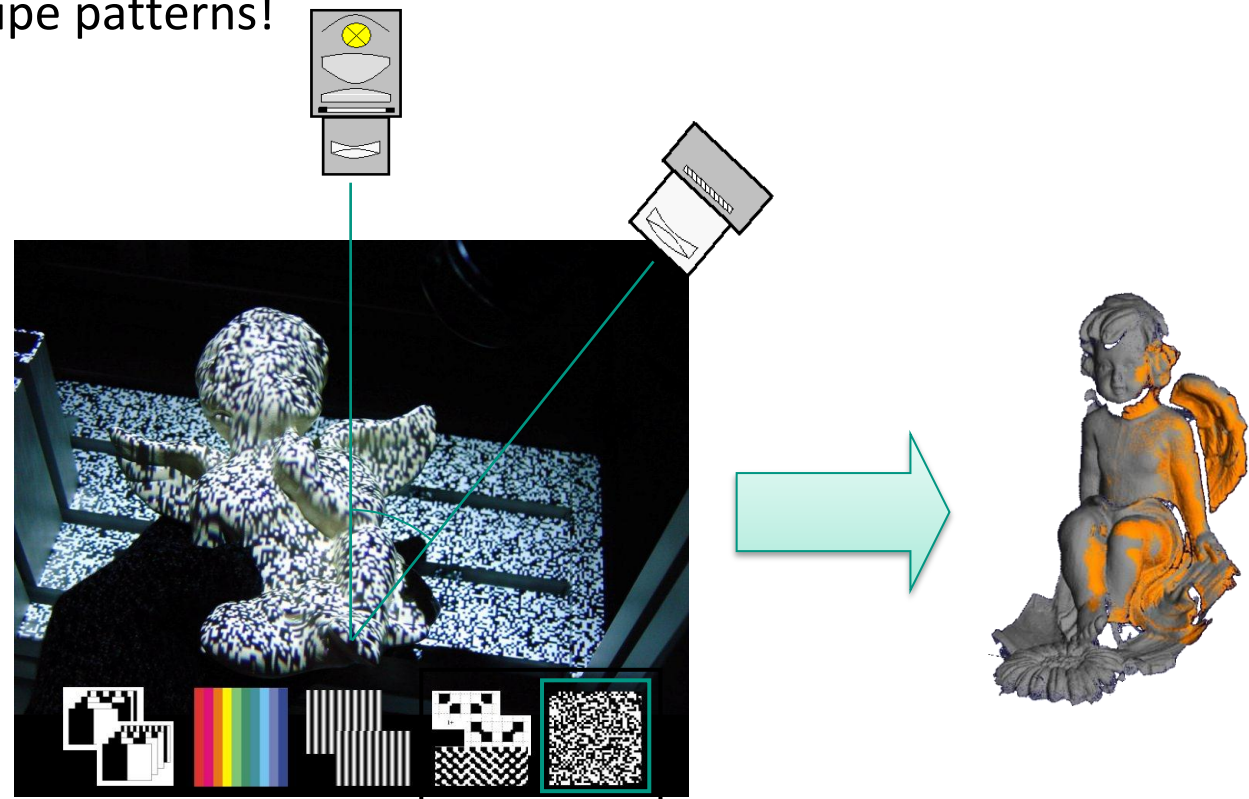

Coded Structured Light: Pattern encoding/decoding

- A pattern is encoded when projecting it onto a surface, a set of regions of the observed projection can be easily matched with the original pattern.
- Project a known pattern onto the scene and infer depth from the deformation of that pattern
- Example: pattern with two-encoded-columns

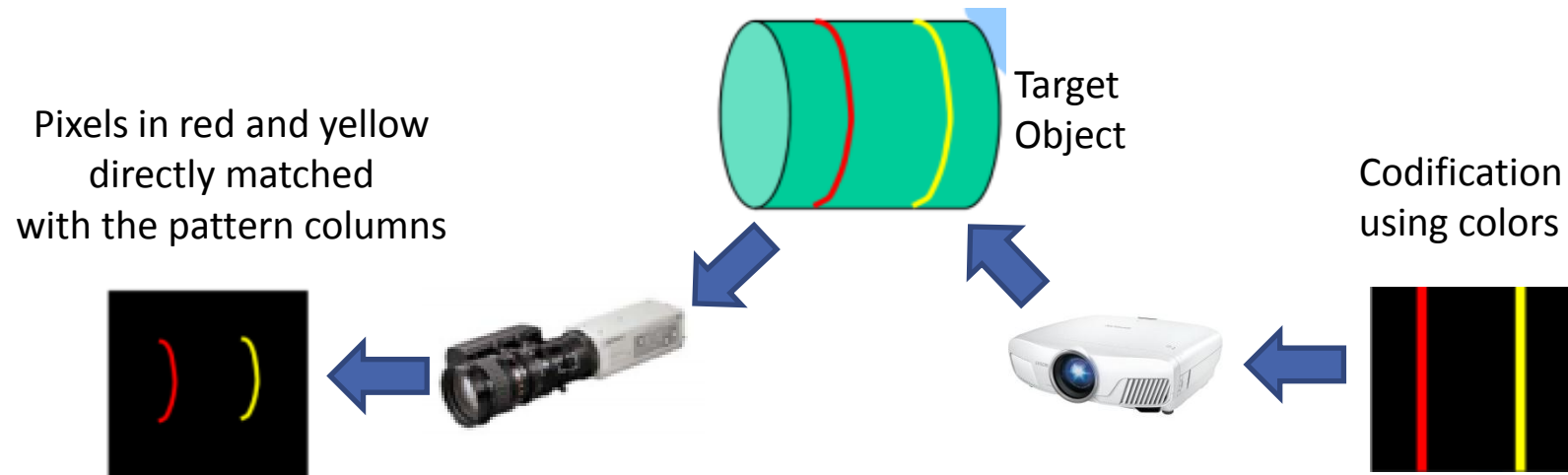

- The projected light pattern is provided as a priori knowledge!
- The process of matching an image region with its corresponding pattern region is known as pattern decoding -> similar to searching correspondences

Answer: Coded stripe patterns

Time Codification

Binary code or Gray code

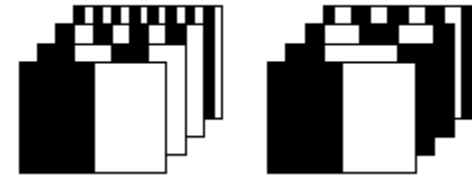

Phase Codification

Sin wave type

Grayscale distribution, in combination with Time Code

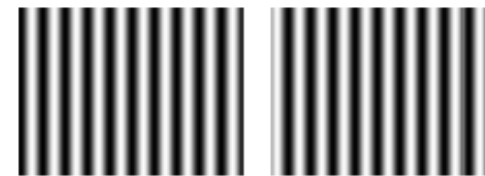

Frequency Codification

Rainbow pattern



Spatial Codification

Point Matrix Code

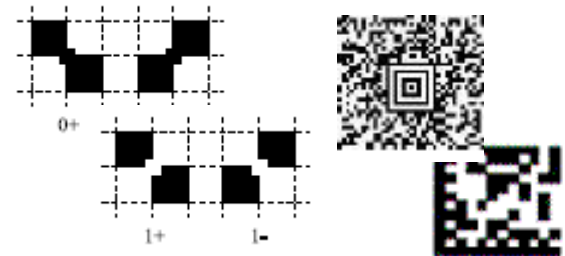

All approaches to solve the correspondence problem: "Which pixel in the camera image corresponds to which pixel in the pattern?"

Pattern Types: Binary Coding

- Assign each stripe a unique illumination code over time
- Only two illumination levels are commonly used, which are coded as 0 and 1.
- $2^n - 1$ stripes in n images
- Advantage: Easy to segment the image patterns
- Drawback: Long scanning time (no real-time capture of moving objects), i.e. Static objects only

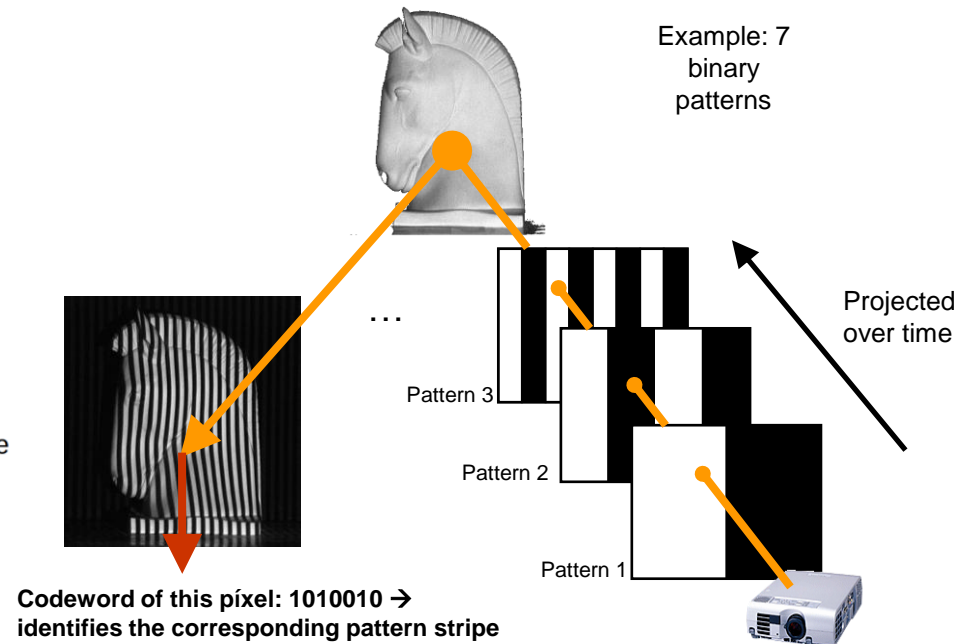

Structured Light for Dynamic Scenes: Example Microsoft Kinect



Structured Light for Dynamic Scenes: Example Microsoft Kinect

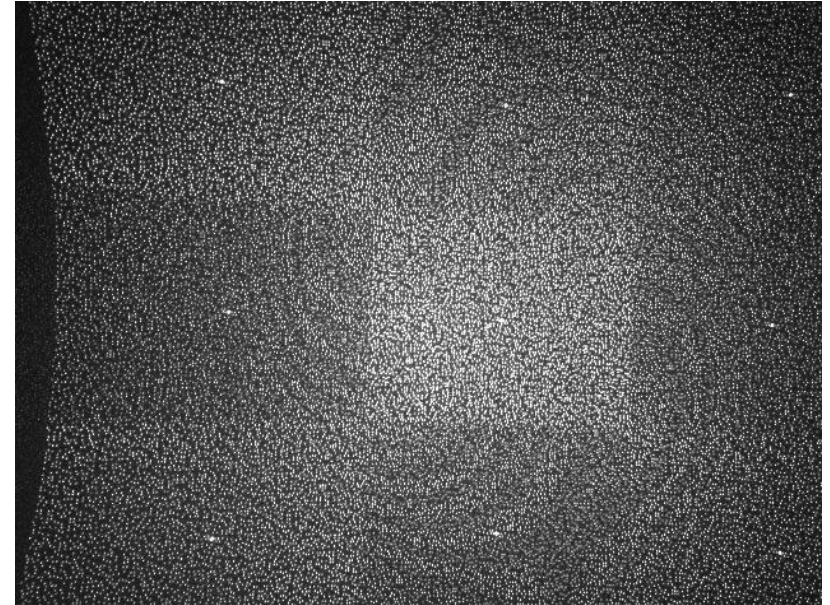

Structured Light for Dynamic Scenes: Example Microsoft Kinect

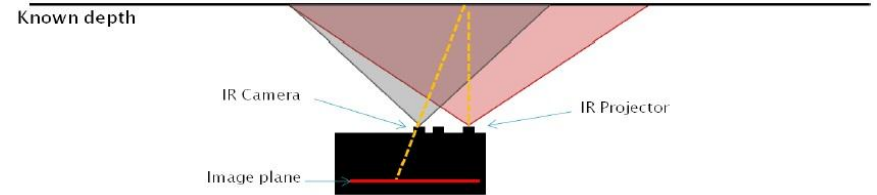

Structured Light for Dynamic Scenes: Example Microsoft Kinect

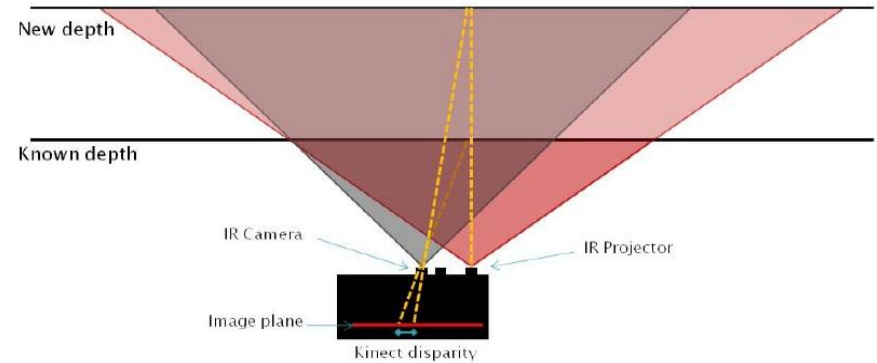

Structured Light for Dynamic Scenes: Example Microsoft Kinect

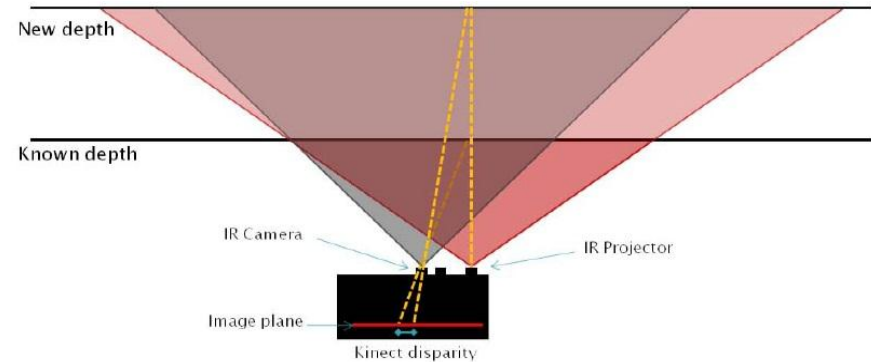

What if we use two Kinects?

+ Advantages

- Cheap!...
- No correspondence problem on homogeneous surfaces

- Disadvantages

- Limited distance (2m)
- Requires good lighting control (restricted to indoor environments)

Structured Light for Dynamic Scenes: Example Microsoft Kinect

- 3D distance sensor - Projection binary infrared pattern
- High resolution color camera
- Measuring range: 0,8m – 3,5m
- Resolution: 640 x 480
- Frequency: 30Hz
- Depth accuracy: 1cm (2m distance)
- Spatial resolution: 3mm (2m distance)

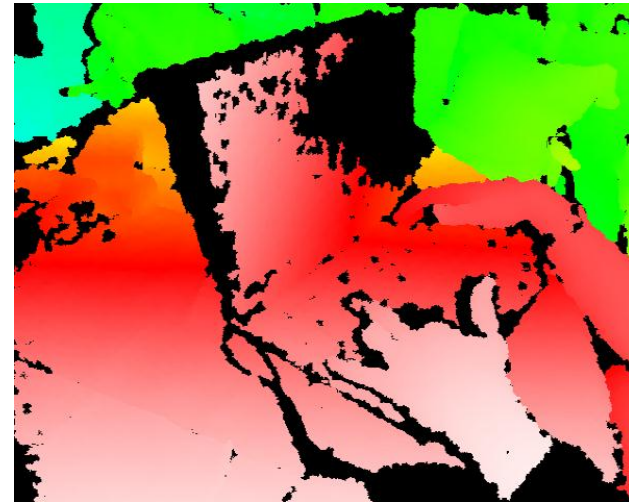

Structured Light for Dynamic Scenes: Example Microsoft Kinect

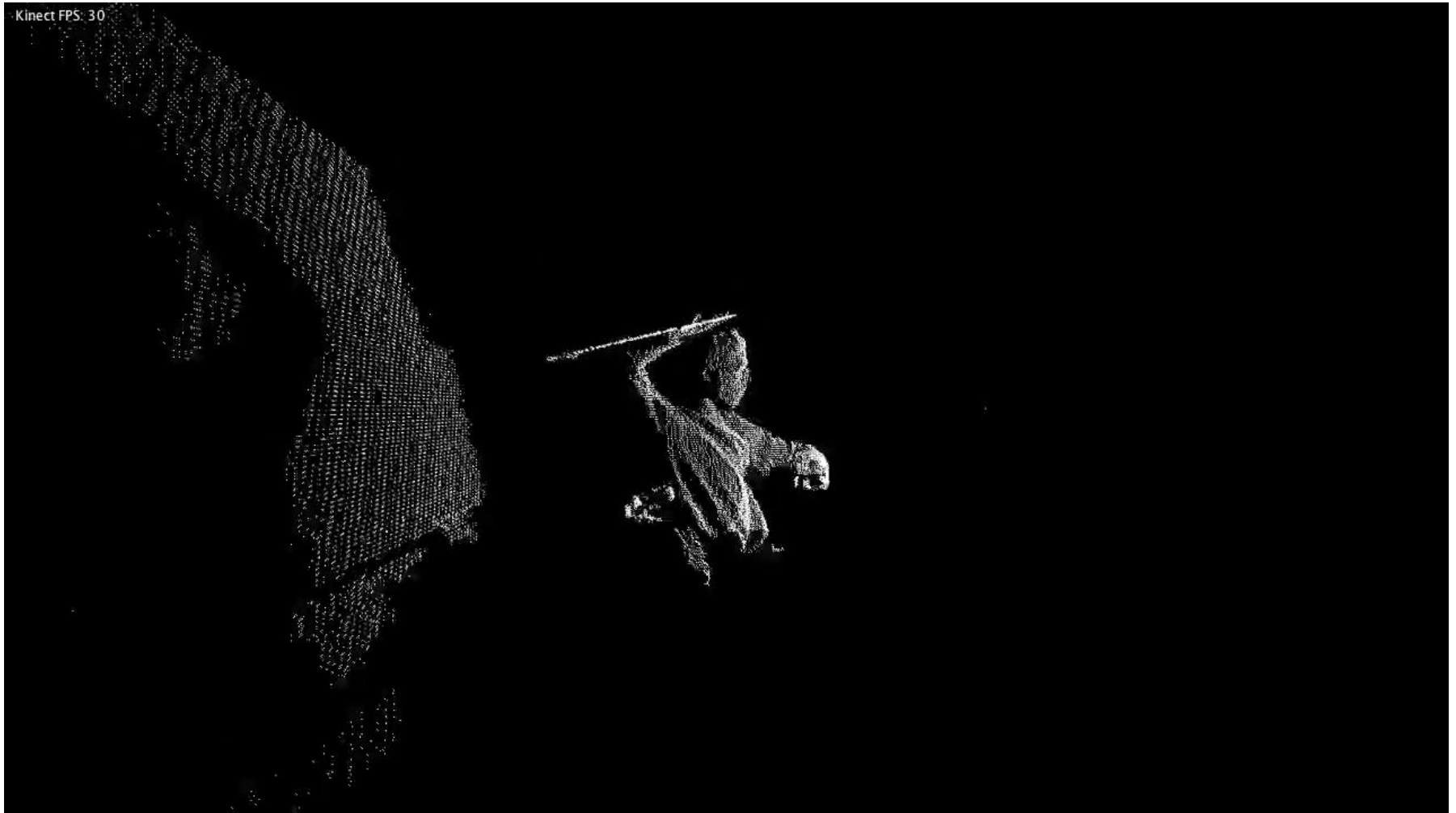

Outlook

- Further (algorithmic) details on active and passive triangulation follow in the course:
 - Optical 3D-Sensors

Literature

- Robotik 3 Book (Skript)
 - The topics covered in chapter 2.2

For more (in German!):

- „Dreidimensionales Computersehen: Gewinnung und Analyse von Tiefenbildern“ by Xiaoyi Jiang, Horst Bunke
 - Chapter 4
- Or on the subject of „Structured Light“:
 - Dissertation „Interaktive 3D-Modellerfassung“ by Tilo Gockel (<http://digbib.ubka.uni-karlsruhe.de/volltexte/documents/2706>)
 - Chapter 2